

Add luxury  
to your life  
with



**New Look**  
*WINDOWS & DOORS*

[www.buywindowstoronto.com](http://www.buywindowstoronto.com)



# ABOUT US

New Look Windows & Doors has served the Greater Toronto Area for more than two decades.

Our mission is to bring every property owner the highest quality products available today and offer services with a focus on dependability, affordability, and trustworthiness. We combine our beliefs in family, friends, and faith in a way that touches on all aspects of our business. Through this, we ensure that every professional relationship is approached and handled with the utmost care and attention. As a result, we enjoy a highly positive reputation in the GTA's window and door marketplace.

When you choose our products, you are choosing highly efficient, attractive solutions that lower your utility bills and increase the value of your home. At New Look, we only offer Energy Advantage Low E glass so every customer can save up to 30% on their bills each year. Not only do you keep more money in your wallet, but you also enjoy greater degrees of comfort in both hot summers and the coldest winters.

Enjoy these benefits along with lifetime warranties that carry over to new owners if you decide to sell your property. We are so confident that our windows and doors will perform exceptionally well for you that we will replace or fix them if anything falls short of your expectations. We guarantee your satisfaction.

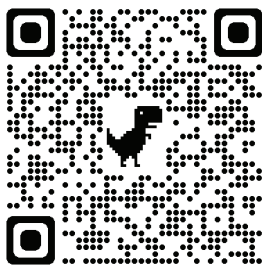

## Read our reviews

The customer is the most important person in our company



# Let New Look make your home look elegant yet energy saving

## Benefits

New Look Windows & Doors will reduce your energy costs for years to come. Our window frames and sashes are fusion welded for strength and durability that provides permanent air and water tight sealing.

Extrusion is made of 100% lead-free uPVC - an environmentally friendly manufacturing process. Our windows are crafted by people who care, using the finest materials and the most recent technology.

All glass units used in our windows are either double or triple glaze insulated with either argon or krypton gas and lowE coating. For easy operation, exceptional style and durability, our windows are equipped with Truth Hardware™. High strength fiberglass screen mesh is standard for improved lifetime.

## Investment

New Look Windows & Doors are the best investment for your home. They are crafted by people who care, built with the finest materials and the most up to date technology available.

At New Look Windows & Doors, we believe trust is earned. That's why we back our products with an industry leading lifetime warranty giving you confidence and peace of mind for years to come.



# A Closer Look at Vinyl Construction

New Look Windows & Doors are made from an exclusive, 100% lead-free uPVC powder compound. This special compound provides our window systems with a better resistance to impact and discolouration. It ensures that they will not crack, blister or warp, while remaining maintenance free.

## Jamb extension

A choice of maintenance free PVC jamb extensions, frame molding and corner blocks are available to enhance interior finish.

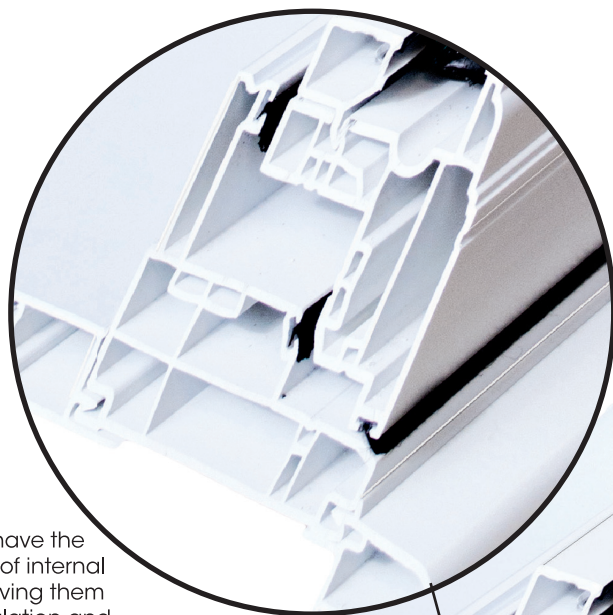

These windows have the highest number of internal air chambers, giving them outstanding insulation and sound abatement qualities, as well as thermal efficiency and increased sturdiness.

Inside trim

## Additional Features:

- Opening mechanism and high-security multipoint locking system come with stainless steel hinges and tracks.
- Hardware mounting is done through a minimum of two uPVC frame walls for secure and durable fastening. Depending on the model, casements open at a full 90°.

Fusion welding corners provide attractive appearance and eliminate the need for adhesive and sealants. There are no imperfections on the completely watertight and airtight surface. Internal walls are also welded for increased overall structural strength.

Sealed glass unit has 13/16" overall thickness. Depending on the model, glazing of different types and thicknesses can be applied, including single, double, triple and Low-E glazing as well as a glazed decorative panel (3/4" to 1-1/8").

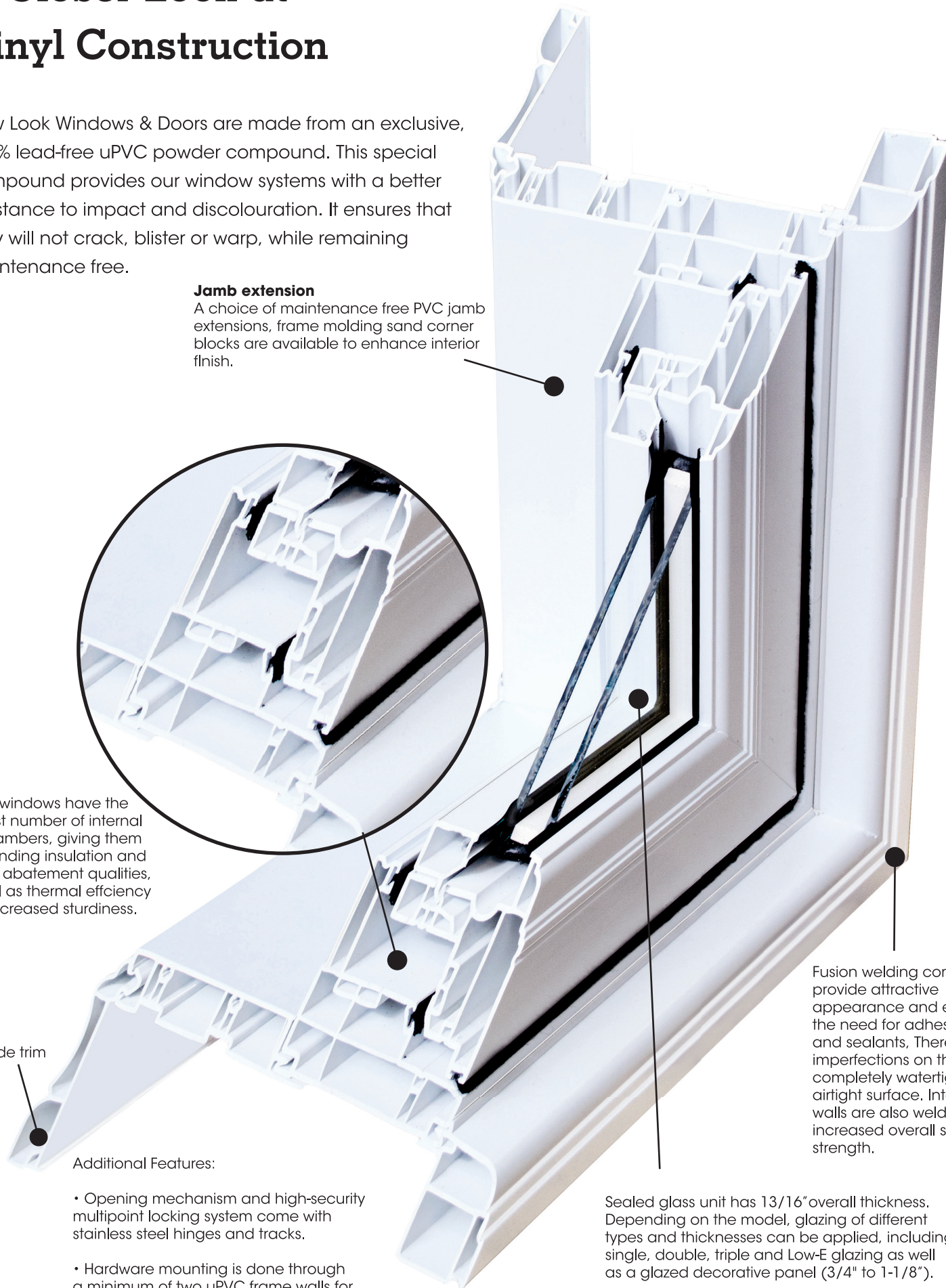

# Triple Glass

Sealed glass unit has 13/16" overall thickness. Depending on the model, glazing of different types and thicknesses can be applied, including single, double, triple and Low-E glazing as well as a glazed decorative panel (3/4" to 1-1/8").



Wood jamb extension with  
3/4" wood return

Triple Glass unit 1-3/8"  
outside thickness



Casement

## Casement

Casement windows offer a broad, unobstructed view as well as an excellent airflow. New Look's classic white vinyl frame complements any home decor, and is highly weather-tight to provide superior energy efficiency with triple sealed glass.

This window swings open to a full 90° for maintenance and easy cleaning from the inside of your house.

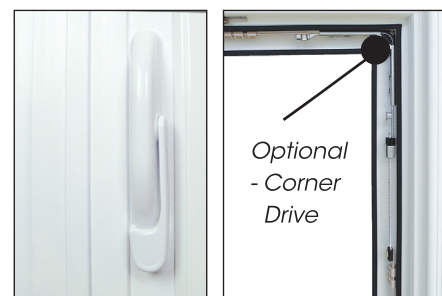



**Awning**

### **Awning**

New Look's awning windows can be installed stand-alone to create a dramatic effect. They can also be used in combination with our fixed windows to create a beautiful view.

Our awning windows have the same energy-saving properties and quality features as our Casement Windows.





Picture



### Picture

New Look offers you maximum versatility in window design through customized picture window frame shapes. Our picture models can function as stand-alone windows or be used in combination with our fixed, casement, double-hung, or single-slider windows.





### **Fixed Casement (High Profile)**

Non-opening, fixed windows are the ideal solutions when you wish to create a broad area of windows in your home. A large mid-section and two vertical side sections allow a panoramic view while providing a sturdy frame.

New Look's fixed windows offer all the features and craftsmanship found in our other models.

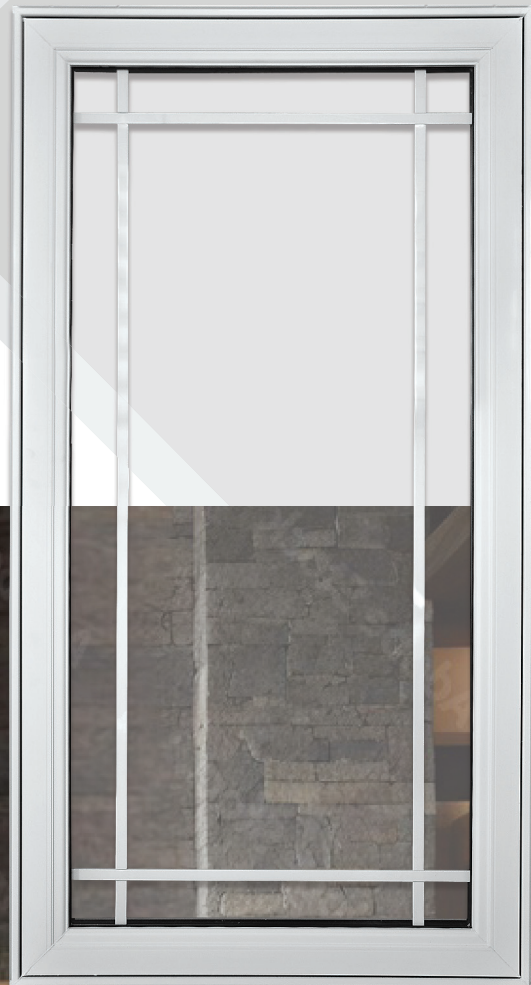

## **Fixed Casement**





## Single Slider



### Single Slider

The most practical and affordable window styles, manufactured by Vinyl-Pro for maximum elegance and energy efficiency. Our Insta-Lok shoe allows sash to slide effortlessly to let fresh air in. This window has the option to either tilt-in or lift-out for maintenance and easy cleaning. It comes with a half size screen.



## Single Hung

Popular and practical windows made more visually appealing through New Look's clean, classic styling, durable, and energy-efficient vinyl. The same spiral sash balance system as our double hung model allows you to safely clean both sides of the glass from the inside. It comes with a half size screen.





# Double Slider

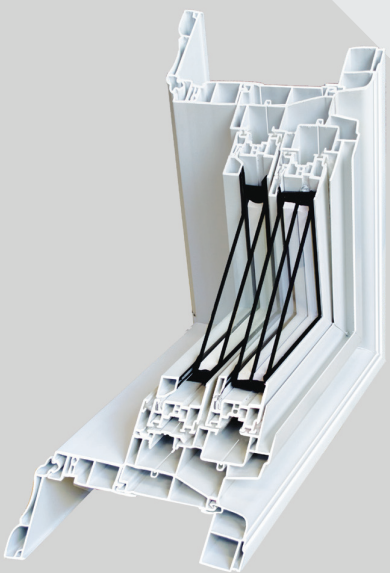

## Double Slider

The ideal choice for areas of the home that require excellent ventilation. Innovative Insta-Lok shoe allows the sash to glide the full length of the window smoothly and securely. Cleaning from inside is a breeze. Comes with a full length screen.

## Double Hung

The classic window style found in many areas in most homes, made more elegant by New Look's tasteful design touches. A efficient spiral sash balance system holds it securely in any position, allowing you to clean the exterior from the inside. A full size screen to provide ventilation from top to bottom.

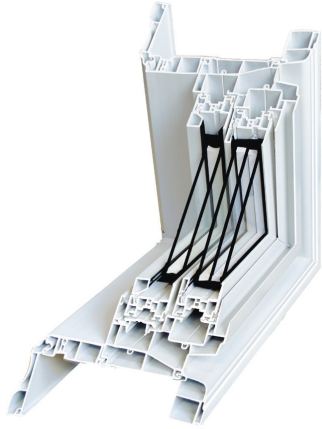

Double Hung



## End Vent Slider



### End Vent Slider

The End Vent Slider window is an often selected option when a sliding window is preferred but the opening is wider than 72". It is also the window of choice in new construction when the builder wants to achieve the look of a casement window combination at a more economical price. The end vent slider has operating sashes at either end that can be tilted in for easy cleaning from the inside of your home.



# Window Grids

The use of creative window grids can make a standard window look extraordinarily special. Today's home owners prefer the look of internal grids in their windows to complement the architectural style of their home. Internal grids, inside the insulated glass unit add style and eliminate cleaning. We provide a wide selection of patterns, finishing and colours to choose from.

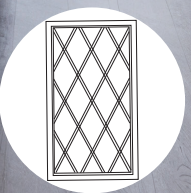
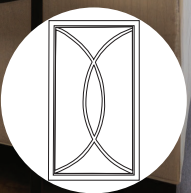
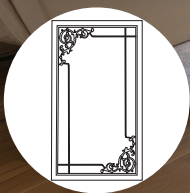

# Specialty Shapes

Specialty shapes can make your home look more unique. From styles like half-round to Octagon, every product is custom made to the exact sizes specified.

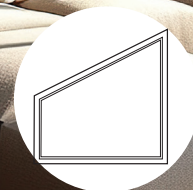

# Protective Packaging for color windows

- All painted frames are protected by protective film from being scratched during installation.
- All painted windows are securely packaged to avoid window from being damaged during transportation.



Protective Film for  
color painted windows



Protective Packaging for  
color painted windows



# Paint & Stain Options

- New Look uses Prolux paint, leader in technology and innovative products in the liquid paint market. Prolux produces coatings for many different substrates including a superb line of paints formulated exclusively for PVC.
- All our color window frames are coated with four layers of paint for lighter colors, and six layers for darker colors. While the industry standard uses two coats for lighter colors and three for darker shades.
- New Look offers a wide range of exciting colours to complement any home improvement project.
- All of our products are painted in boxes instead of in liners.
- All painted frames come with a 15 year warranty.
- New Look is one of few companies that offers on-site painting services for minor paint damages during installation.
- New Look also offers a three stage stain for both the exterior and interior parts of the window to achieve the look of natural wood finishing.

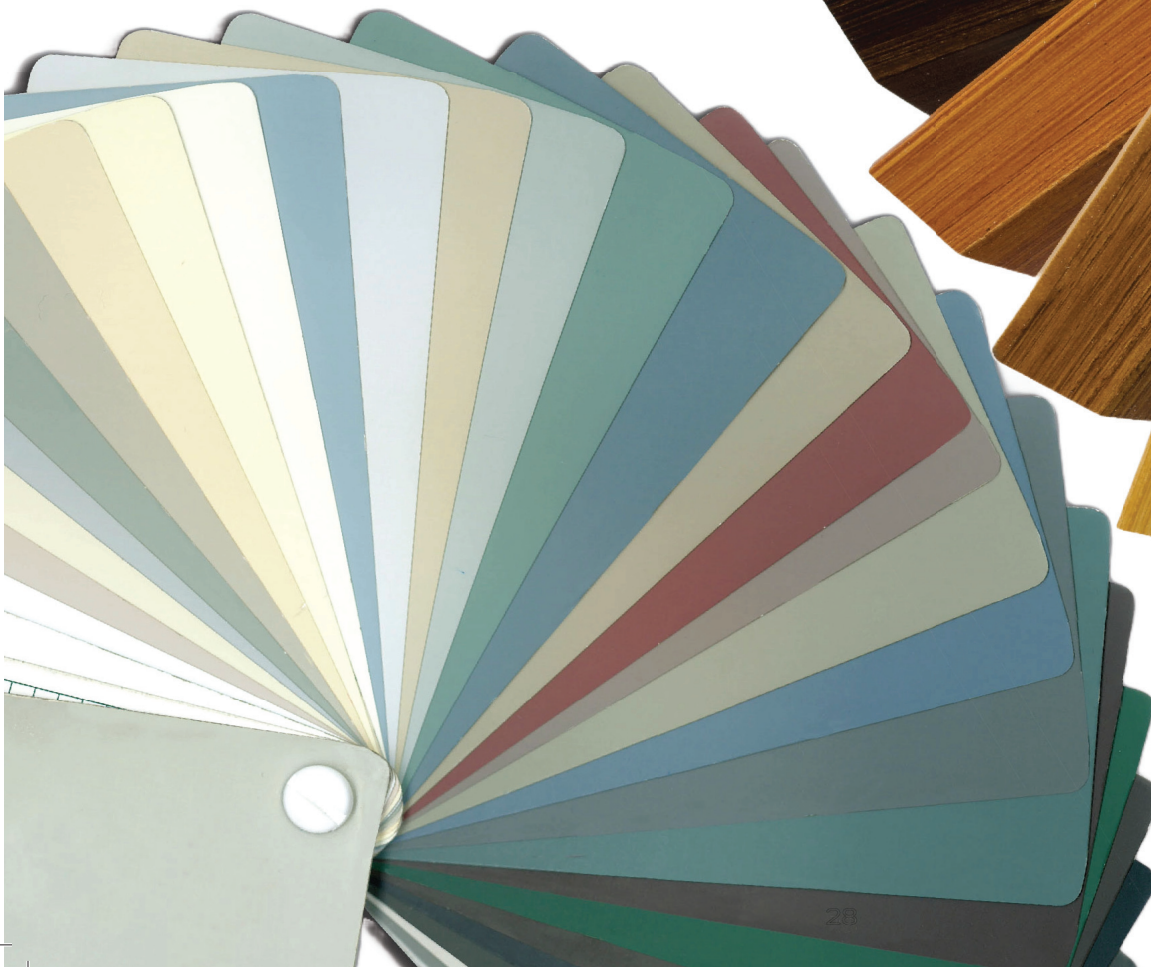

# CARDINAL ARCHITECTURAL GLASS

## LoE 180 - Passive solar control glass



Windows provide natural light and beautiful views, but they can account for up to 50% of a home's heating and cooling energy consumption. Cardinal LoE 180 helps keep your home warm and cozy by blocking heat loss in winter, while also reducing summer solar gain by 10% compared to clear double-pane glass. Its low u-factor also blocks heat gain from outside, making it an energy-saving solution year-round. The insulating capability of cardinal LoE 180 is particularly beneficial for cold climates, improving indoor comfort and allowing for proper humidity control, which promotes a healthier living environment.



## LoE 272 - Glass for all climates



Cardinal's LoE 272 coated glass provides year-round comfort by rejecting the sun's heat and UV rays in the summer, and reflecting heat back into the room in the winter. Choosing windows that provide high levels of comfort and energy savings year-round is essential, and selecting the right glass is crucial. Trust LoE 272 glass to go beyond ordinary Low-E glass and handle any weather conditions.



## LoE 366 - Ultimate glass for all climates



Get year-round comfort and energy savings with LoE<sup>3</sup> 366 glass. It strikes the perfect balance between solar control and high visibility, making it the go-to choice for energy star compliance in all zones. Unlike ordinary glass or tinted glass that can't handle the heat and can spoil the view, LoE<sup>3</sup> 366 is specially formulated to keep your home cool and comfortable while letting in more light. It also blocks 95% of UV rays, protecting your furniture, carpets, curtains, and wall coverings from fading.



## LoE i89 - Enhanced winter performance glass



Our double-pane windows now have triple-pane performance with the addition of LoE i89 coating on the indoor pane, which reflects escaping heat back into the room and lowers u-factors. When combined with our LoE<sup>2</sup> or LoE<sup>3</sup> glass and argon fill, our double-pane windows deliver better performance than clear triple-pane windows with a center of glass u-factor of just 0.20 compared to 0.37 with clear triple-pane. LoE i89 also has a smooth and scratch-resistant surface, making it easy to clean, and allowing it to reflect internal heat back into the room for added comfort.



# Super Spacer<sup>®</sup> COMPARISON

## Comparing Super Spacer<sup>®</sup> and XL Edge<sup>™</sup>



### NO-Metal Super Spacer<sup>®</sup>

Patented all-foam design dramatically reduces condensation, delivering the clearest picture in Warm Edge technology.



### Windows made with Cardinal XL Edge<sup>™</sup>

Mid-performance spacer systems that still contain metal do little to improve condensation resistance.

- “Super Spacer is the world's leading 100% polymer foam, NO-Metal Spacing System.”
- Super Spacer is 950 times less conductive than aluminum spacers, and 85 times less conductive than stainless steel.
- Windows with Super Spacer result in improved energy savings and window performance.
- Windows with Super Spacer have significantly more condensation resistance than windows with XL Edge.

### Super Spacer<sup>®</sup> Comparison **Up to 70% better.**

As much as +18.5°F warmer temperature at the edge of the glass.  
Inside temp. 70°F  
Outside temp. 0°F.

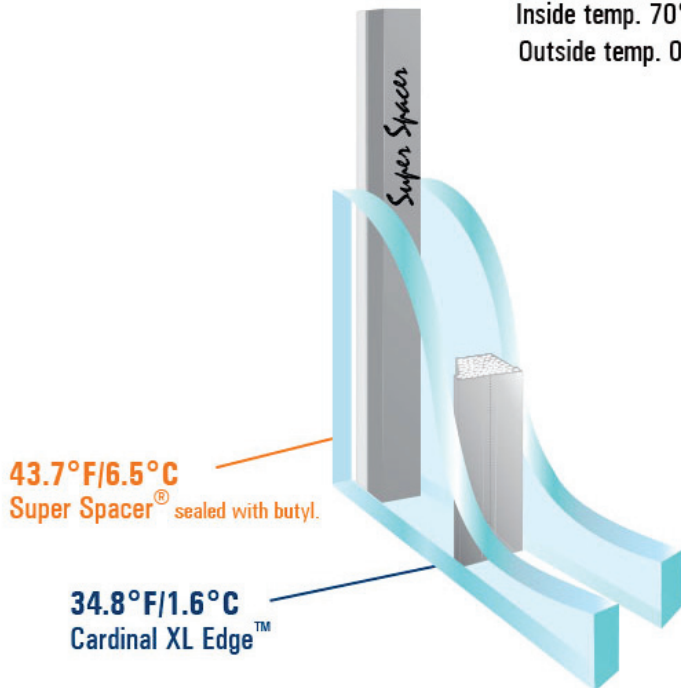

### The Lowest **Conductivity & IG U-factor**

**Block heat from escaping through the glass edge**

The all-foam formula of Super Spacer<sup>®</sup> is proven to be less conductive providing optimal thermal performance and the lowest U-Value in the industry. Reducing conductivity also reduces condensation.

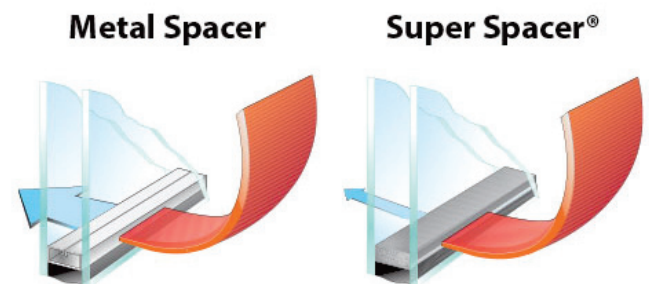

Spacer System	Condensation Resistance	Edge of Glass Temperature	Effective Thermal Conductivity	Total IGU Factor
Super Spacer <sup>®</sup> Structural Foam / butyl	44.9	43.7°F / 6.5°C	0.171 W/m·K	0.277
Cardinal XL Edge <sup>™</sup>	32.2	34.8°F / 1.56°C	0.459 W/m·K	0.293

Simulations performed by Enermodal Engineering Ltd. using Window 5.2 and Therm 5.2 as per NFRC100-2001. Outside temperature 0°F, inside temperature 70°F. Low-E glass is Cardinal Low-e<sup>2</sup> 272. All air spaces are .500" wide, IGUs are 24" x 48". [Test Reports EIG906w, EIG10005, EIG10009w]

# Impact Glass By New Look

We are all concerned about the safety of our families and homes.

Impact Glass provides a level of security, serenity and custom design options that cannot be realized with ordinary glass.

Specialized security glazing used in Impact Glass transforms a window into a fortified line of defense. Our Impact Glass is built to resist break-ins and prevent forced entry, keeping your home and property safer. With a variety of glazing options, we have the perfect solution for your needs.

## STANDARD GLASS

Offers minimal protection to resist break-ins and prevent forced entry.



10%



## LAMINATED GLASS

Basic security glazing consists of an interlayer sandwiched between two glass layers. It offers owners the peace of mind that accidental human impact will not shatter the affected area.



50%



## IMPACT GLASS

Enhanced security glazing is suitable for areas at risk of burglary. This level of risk prevention will extend deterrence to entry.



90%

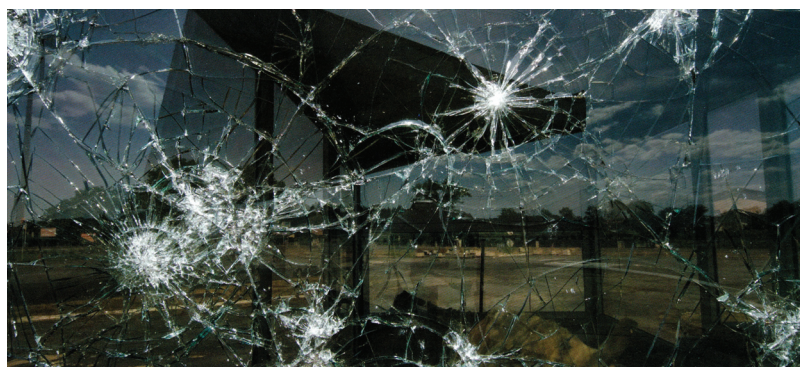
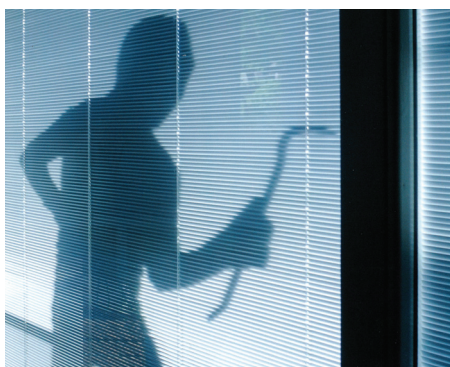
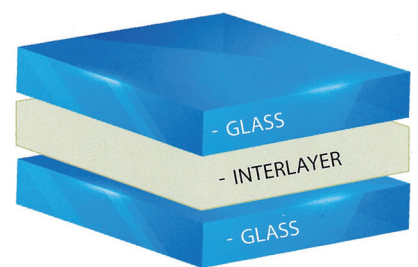

# Glass Options

## Privacy Glass

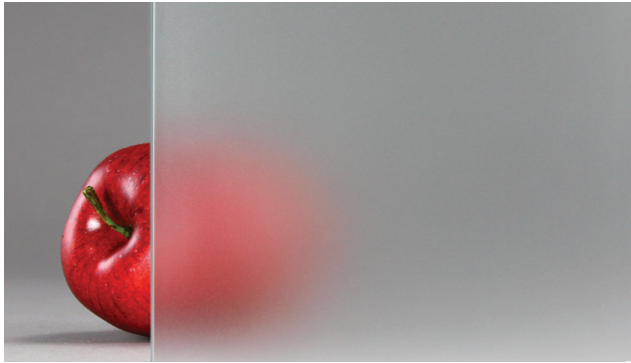

Acid Etched

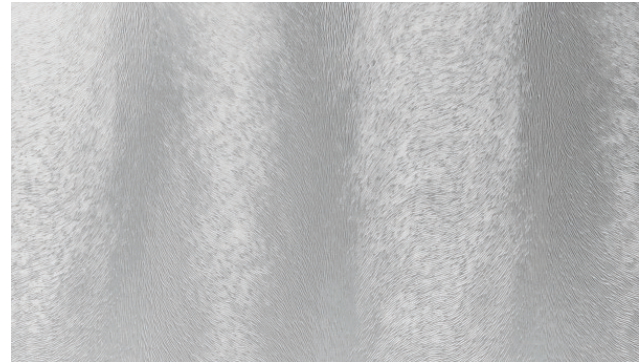

Chinchilla

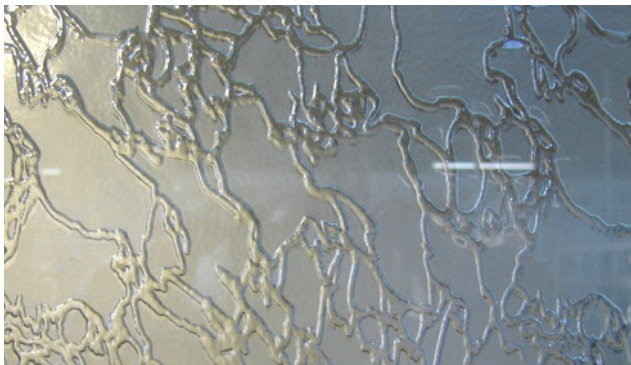

Delta Frost



Sparkolite



Pinhead



Glue Chip

# Casing Options

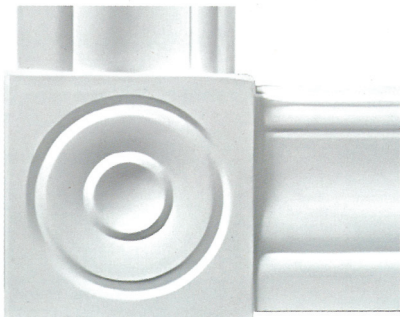

Square Rosette

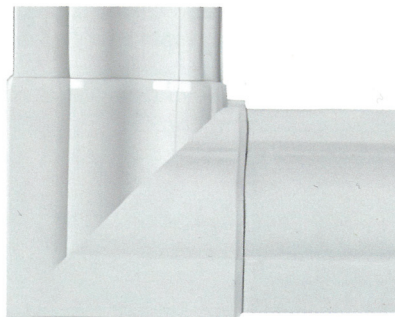

Modern Rosette



Wood Casing

# Steel And Fiberglass Doors



## Steel Doors

The New Look Elegance steel door collection seamlessly combines classic door features with the durability of steel.

The lock area is reinforced with a lock block for added protection, and the bottom rails are made with high-quality composite material that resists rotting. The door's smooth, galvanized white surface requires no additional finishing, but can be painted to match the exterior and interior walls of your home, if desired. For those seeking an extra touch of elegance, decorative glass inserts are available as an option.



[www.buywindowstoronto.com](http://www.buywindowstoronto.com)

## Fiberglass Doors

If you're looking for a low-maintenance door that mimics the look and feel of a traditional wooden one, take a look at the fiberglass panel and side-lite models in our Entry Door Series collection. Our doors are available in a wide range of wooden patterns, including oak and mahogany grains. You can even choose a smooth surface that we can paint to match your desired color or pattern. Oak and mahogany grains can also be stained for a more realistic wood-like appearance.



[www.buywindowstoronto.com](http://www.buywindowstoronto.com)



# Sliding Doors

Our door collection is available in two-panel, three-panel, and four-panel units, our automated manufacturing facilities make custom sizes a breeze.

Our uPVC doors are top-notch, offering superior protection and insulation to enhance the safety and comfort of your home. Our Ultra Patio Doors are equipped with our Solar Solutions glass features upon request, which improves energy efficiency and maximizes home security. Trust our collection to provide you with the quality, style, and customization options you're looking for in a door. Compared to other manufacturers, our standard blinds program also offers a wider range of sizes.

## Standard features

- Oversized sash frames create a luxurious look
- Soft touch fin weather strip coupled with precision tandem rollers
- Special multi-finned weather strip at both top and bottom interlock position effectively reduce air infiltration
- Twin point lock and kick lock as a standard
- Superior 2" x 1/2" screen with fiberglass mesh, adjustable steel rollers, lock with pull handles, and heavy duty zinc keeper
- Hi-efficiency glass packages for energy savings and general home comfort



[www.buywindowstoronto.com](http://www.buywindowstoronto.com)

## Eagle Multi-Point Locking System



As soon as the door is pulled shut, the automatic latchbolts instantly throw 20mm and are secured to prevent them being forced back. By turning the key or the knob, it will engage the deadbolt and lock the top and bottom latchbolts to become a 3 deadbolt locking system.

- 3-point, one piece locking system for 6' 8" and 8' doors
- Heavy duty mortise construction with reinforced lever return spring system
- Locking by US-cylinder with 90° turn of key or thumb-turn
- No lifting of handle to engage locking points
- Top and bottom Automatic latchbolts projection from 10 to 20mm:
  - Provide security against forced entry
  - Help prevent air infiltration from gasket
  - Protect the door panel from warping
- 1'(25mm) throw on deadbolt
- Non handed, latch easily reversible
- 8mm square spindle
- 92mm centres (spindle to cylinder)
- Handle height variable (36" recommended)
- 16mm stainless steel faceplate with radius ends for easy installation and cleaner look
- Same hardware groove detail throughout our entire door lock program (jig, router base and bits available)
- Extension with additional lock point is available for doors taller than 8' (6-33479-04-0-8B)
- To be used with lever handle set (US-cylinder above handle)

## Astragal Mortise Lock for Inactive Doors



- None handed, easy to reach and operate
- 20mm stainless steel faceplate can be installed after finishing the door
- Adjustable backset (rod depth) 24-33 mm. Accommodate different astragal thickness from 1/2" to 1 1/8"
- Two screws capture each rod securely in place, no threaded rods are required
- 10mm rods extend 25mm (1")
- Straight rod cut off from the hookup side, no grinding tip or retreading required
- Fixed rod sizes available for standard doors
- For doors up to 11' height
- Easily accessible rod height adjustment
- Jig and router bit available
- Adjustable top and bottom striker cups: in and out 1mm, sideways 6mm. Two height sizes: 22 and 27mm
- Faceplate available with stainless steel finish



## Pull Handles



Square Round Round Offset Angled

Sizes: 48", 60", 72"

Finishes: Stainless Steel, Black

## Bluetooth Locks with Keypad



danalock Bluetooth

Compatible with: Berkeley, Roma, Country, Miami, Berlin



# Patio Door Hardware

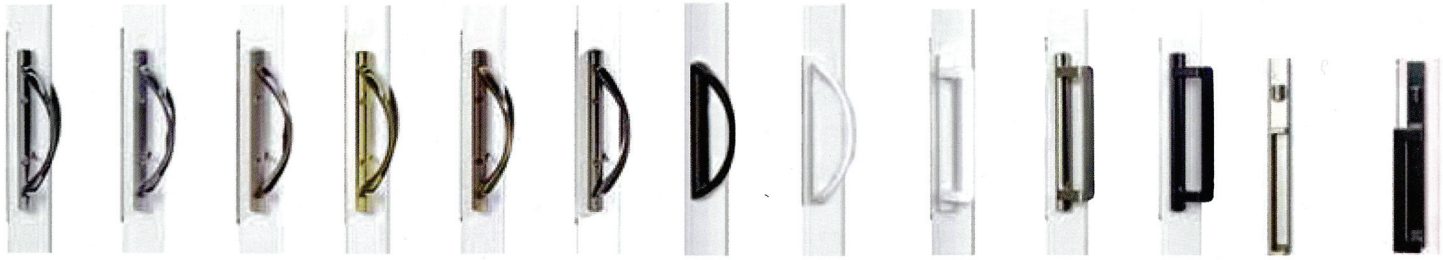

Verona

Siena

Sorrento

San Remo

# Additional Options



Kick Lock



Guardian Lock

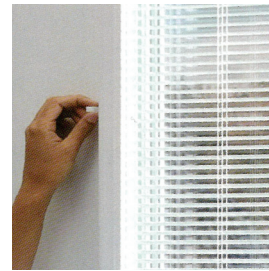

Mini Blinds

# Multi-Point Lock

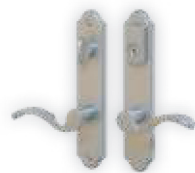

Capri



Torino



Venice



Roma



Miami



Berlin



# New Look Warranty



for UPVC Vinyl Window  
(Fully transferable warranty)

## EXTENDED LIFETIME WARRANTY ON WHITE VINYL FRAME AND VINYL SASH

New Look Windows are warranted against such defects in material that might result in blistering, peeling, flaking, corroding and fading of the frame or sash members for the lifetime of the product from the date of installation.

## PAINTED VINYL FRAMES AND SASHES

15 year warranty on painted frames and sashes are warranted against such defects in material and workmanship that might result from paint peeling, flaking, cracking and major discoloration for a period of ten (10) years that is not caused by exposure to sunlight, heat or noxious or abrasive materials.

## LIFETIME WARRANTY ON INSULATING GLASS

New Look guarantees that the insulating glass in the window will not develop noticeable visual obstructions due to film formation or dust accumulation between the panes for the lifetime of the window, provided all warranty terms are met. However, this warranty does not cover any form of glass breakage.

## LIFETIME WARRANTY ON HARDWARE

New Look warrants that the hardware shall remain in good operational condition from the date of installation. For crank mechanisms on casement and awning windows, over tightening of the mechanism will cause pre-mature failure and is not covered under this warranty.

## EXCLUSIONS FROM WARRANTY COVERAGE

Damages resulting from the following are excluded from coverage under this Warranty:

1. Damage from harmful pollutants, corrosion of non-vinyl parts due to coastal areas or damage caused by extreme heat, physical stress or high humidity.
2. Any damage to the window or window components due to the settlement of the building structure.

3. Any damage caused by wind, hail, lightning or other incident of weather, deemed as an act of God.

4. Minor imperfections in windows and doors that do not affect the product's structural integrity or obscure vision.

## INSTALLATION LIABILITIES

5. Any window which has been repaired or modified by any person other than a factory-trained Service Technician or authorized New Look representative or any Non-New Look add-on or replacement parts added to the window(s).

6. Any defect, malfunction, or failure to perform, which has occurred due to unreasonable use, improper application, or the failure to perform reasonable or necessary maintenance.

7. Condensation on windows, which may occur as a natural result of humidity within the house or building area. Please refer to: <http://oeo.nrcan.gc.ca/> for condensation prevention tips.

## WARRANTY LIMITATIONS

New Look's liability is limited solely and exclusively to repair or replace and to substitute parts, at the discretion of New Look, and under no circumstances will New Look be liable for incidental or consequential charges, such as, but not limited to, labour costs for any purpose, inconvenience, damage or injury to persons or to property, or any other expense. This Warranty will be deemed null and void if the owner/purchaser modifies or otherwise alters in any way the product after installation without the written consent of New Look, if the product is used for a purpose not intended, or otherwise outside the accepted and advised use, and if harmful cleaning solutions and abrasive compounds are used.

## QUALITY STANDARDS

All New Look products are manufactured according to New Look standard manufacturing tolerances. With quality construction, committed staff, and technology, we ensure the best possible products and service available.

Date of Installation \_\_\_\_\_ Customer Name \_\_\_\_\_

Address \_\_\_\_\_



[www.buywindowstoronto.com](http://www.buywindowstoronto.com)



# Manufacturing Facility



- All our vinyl windows are fusion welded with a burn off 1/4" to ensure durability and strength.
- 45° cuts are done with digital precision to provide maximum strength while welding.
- CNC corner cleaning technology eliminates hand scratching of weld lips and provides the best automated finish available in the industry.
- At New Look, we also make our own sealed glass thermo units to ensure prompt delivery & quality.

☎ 416-571-3107  
1-855-931-6111  
✉ info@buywindowstoronto.com

We have become  
the largest and  
most trusted brand  
in the window industry



Showroom address  
3350 Langstaff Rd, Concord, ON L4K 4Z6  
By appointment only